

CONNECTION DIAGRAM

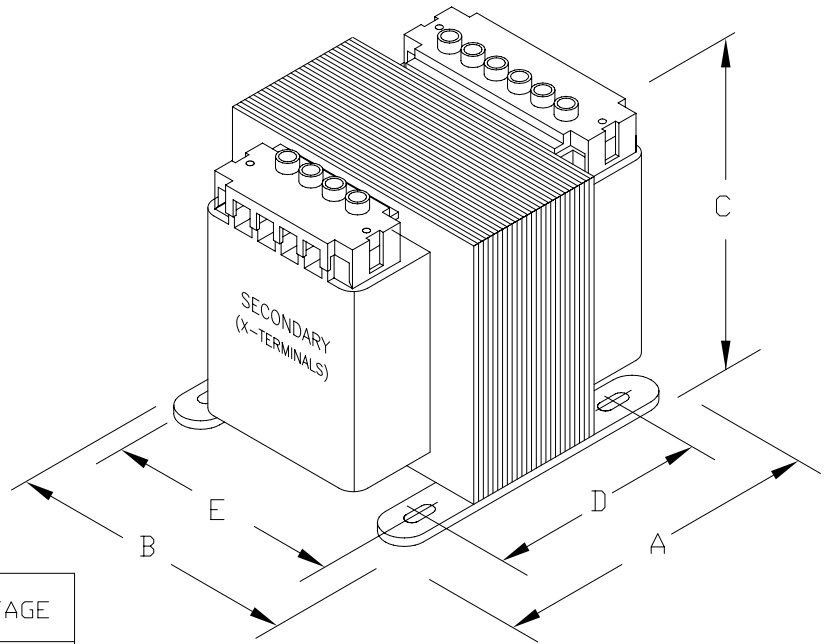

CONNECTION TABLE

INPUT VOLTAGE				OUTPUT VOLTAGE		
H1-H2	H1-H3	H1-H4	H1-H5	X1-X2	X1-X3	X1-X4
208			500	85	100	110
220	380	440	550	91	110	120
230	400	460	575	95	115	125
240	416	480	600	99	120	130

PROVIDED WITH SAFE TOUCH TERMINAL COVERS
NO INTEGRAL FUSING CAPABILITY.

DIMENSIONS							APPROX. WT. LBS (KG)
	A	B	C	D	E	MTG. SLOTS	
INCHES (MM)	7.38 (187)	5.25 (133)	4.50 (114)	5.88 (149)	4.38 (111)	0.313X1.063 (8.0X27.0)	



CAT.NO.	B750-2287-GAF			CONST. ENCAPSULATED		UL LISTED	
				MODEL GLOBALTRAN			
RATING							SP CERTIFIED
OUTPUT AMPS	5.77	PRIMARY V	240/416/480/600, 230/400/460/575, 220/380/440/550, 208/500		TEMP. CLASS	HZ 50/60	
VA	750	SECONDARY V	99/120/130, 95/115/125, 91/110/120, 85/100/110		130°C	REVISION G	CE IEC 61558